



Devices thru Material Innovation

**NEC/TOKIN**

**Vol. 10**

# ***NEC TOKIN Sensors***

W50 T10  
SENSOR



- All specifications in this catalog and production status of products are subject to change without notice. Prior to the purchase, please contact NEC TOKIN for updated product data.
- Please request for a specification sheet for detailed product data prior to the purchase.
- Before using the product in this catalog, please read "Precautions" and other safety precautions listed in the printed version catalog.

# CONTENTS

Thermal Reed Switch TRS® .....	4
TRS Series Approved by UL, CSA, and VDE .....	8
Thermal Guard OHD® .....	9
Current Transformer Low Current Type .....	12
Zero-Phase Current Transformer ZCT .....	14
Magnetic Direct Current Sensor MDCS® .....	16
Magnetic Type Proximity Switches TMRS® Series .....	20
Inquiries .....	25



- All specifications in this catalog and production status of products are subject to change without notice. Prior to the purchase, please contact NEC TOKIN for updated product data.
- Please request for a specification sheet for detailed product data prior to the purchase.
- Before using the product in this catalog, please read "Precautions" and other safety precautions listed in the printed version catalog.

# INTRODUCTION

Advances in LSIs, microcomputers and power devices enable ever more efficient use of energy, finer control and greater ease of use. In this way industry is promoting consumer appliances with increasingly sophisticated "intelligent" functions. And with these developments there is a burgeoning need for advanced, highly reliable sensors with capabilities corresponding to the human' five senses.

NEC TOKIN seeks to commercialize creative products fusing new material technologies with new applications, developing and commercializing a broad range of sensor devices based on outstanding materials technologies covering properties such as magnetism, piezoelectronics and optics.

This catalog introduces different kinds of sensors, including thermosensors, current sensors and magnetic sensors. Besides the items shown here we also offer an extensive line of sensor-related products and are continually developing new sensors, so please feel free to ask us about anything you might need. We look forward to being able to serve you.



- All specifications in this catalog and production status of products are subject to change without notice. Prior to the purchase, please contact NEC TOKIN for updated product data.
- Please request for a specification sheet for detailed product data prior to the purchase.
- Before using the product in this catalog, please read "Precautions" and other safety precautions listed in the printed version catalog.

# Thermal Reed Switch TRS®

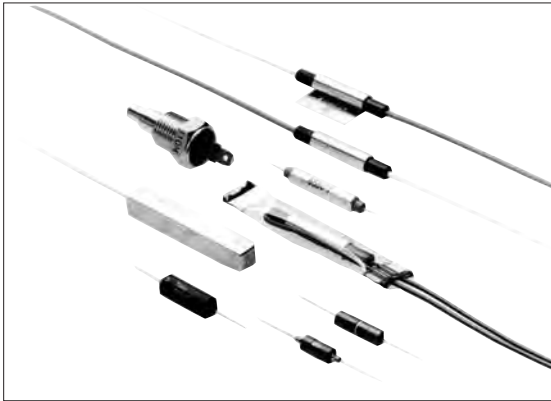

## Outline

NEC TOKIN led the world in recognizing and realizing the potential of ferrite's Curie temperature. The result is Thermorite®, a temperature-sensing magnetic material. Ever since the introduction of this product, NEC TOKIN has reigned as the top manufacturer of Curie-temperature-utilizing control devices, developing many products with new functions. Among these, the Thermal Reed Switch (TRS®) is the chief product, with patents in the United States and Japan. Its superiority as a highly reliable, precise temperature-sensitive switch ideal for promoting energy conservation has been attested to by the International Relay Association. There are already more than 300 million in use, and with the addition of TRS® varieties approved by UL, CSA and other safety standards, the lineup just keeps getting better.

## Features

- High reliability (long product lifetime)
- Excellent temperature accuracy ( $\pm 2.5^{\circ}\text{C}$ ,  $\pm 1^{\circ}\text{C}$ )
- Wide range of operating temperature available ( $-10^{\circ}\text{C}$  to  $+130^{\circ}\text{C}$ )
- Excellent environmental resistance (contacts are encased in a glass tube)

## Markings

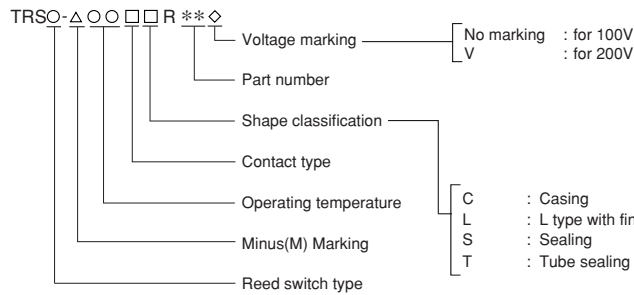

## Electrical Characteristics

Reed switch type	For 100 V					For 200 V	
	TRS06-	TRS1	TRS3-	TRS5-	TRS6-	TRS5-	TRS1-
Maximum opening/closing voltage (V)	110 AC-DC	140 AC 200 DC	140 AC 200 DC	140 AC 200 DC	140 AC	264 AC	220 AC
Maximum opening/closing current (A)	0.3 AC-DC	0.5 AC-DC	0.5 AC-DC	0.55 AC-DC	0.65 AC	0.275 AC	0.045 AC
Maximum opening/closing power (W)	6 AC-DC	10 AC-DC	35 AC 10 DC	60.5 AC 10 DC	72 AC	60.5 AC	10 AC

\* Please refer to pages 6 to 7 as rated values vary depending on product types (shape classification).



- All specifications in this catalog and production status of products are subject to change without notice. Prior to the purchase, please contact NEC TOKIN for updated product data.
- Please request for a specification sheet for detailed product data prior to the purchase.
- Before using the product in this catalog, please read "Precautions" and other safety precautions listed in the printed version catalog.

## Structures and Principles of Operation

Thermal Reed Switches (TRS<sup>®</sup>) are temperature-sensing switches composed of a magnet and a temperature-sensing soft ferromagnetic substance called Thermorite<sup>®</sup>. This material's saturation magnetic flux density decreases as the temperature increases, and it turns into a paramagnetic substance at the Curie temperature.

### (a) Normally closed type

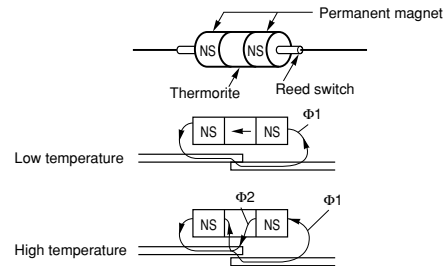

### (b) Normally open type

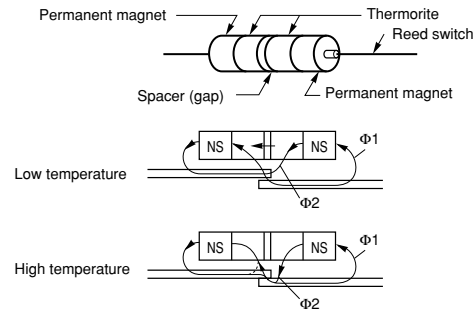

#### Before Using Thermal Reed Switch (TRS<sup>®</sup>)

- Please ask for a copy of specification and check the contents thoroughly before the actual use.
  - Please contact us before deciding your specifications.
  - Do not use in close proximity to strongly magnetized parts.
  - Do not use if dropped or strongly shocked.
  - Do NOT use with greater load than specified.
- When installing these switches in circuits prone to producing surge voltage (inductive load) or rush current (in lamps and motors), an appropriate switch type should be used, or a contact point protection circuit added.
- Avoid stress (especially torsion) in case of additional processing.
  - Each reed switch has a specific resonance frequency. Please contact us when an oscillation is added.

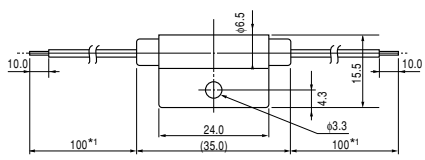
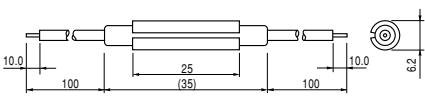
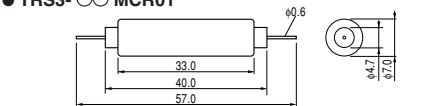
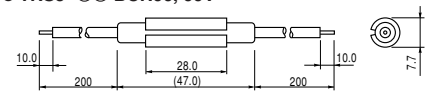
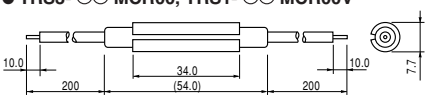
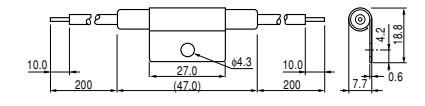
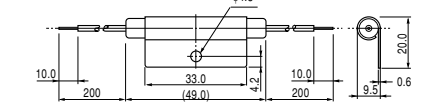

- All specifications in this catalog and production status of products are subject to change without notice. Prior to the purchase, please contact NEC TOKIN for updated product data.
- Please request for a specification sheet for detailed product data prior to the purchase.
- Before using the product in this catalog, please read "Precautions" and other safety precautions listed in the printed version catalog.

	Part Number / Shape / Dimensions	Operating temperature range*1	Operating temperature precision	Differential Temperature	Application(s)	Features
Compact Type	<ul style="list-style-type: none"> <li>● TRS06-○○ BLR001</li> </ul>  <ul style="list-style-type: none"> <li>● TRS06-○○ BCR001</li> </ul>  <p>(mm)</p>	30°C to 130°C	±5°C		Power supplies Recharge temperature detection	Compact
C Type	<ul style="list-style-type: none"> <li>● TRS5-○○ BCR01</li> <li>● TRS5-○○ BCR01V</li> <li>● TRS1-○○ MCR01V</li> <li>● TRS3-○○ MCR01</li> </ul>  <ul style="list-style-type: none"> <li>● TRS5-○○ BCR00, 00V</li> </ul>  <ul style="list-style-type: none"> <li>● TRS3-○○ MCR00, TRS1-○○ MCR00V</li> </ul>  <p>(mm)</p>	0°C to 120°C	±2.5°C	10°C max.	Rice cookers Yogurt makers Hot water heaters Photocopiers	General-purpose
L Type (Break Type)	<ul style="list-style-type: none"> <li>● TRS5-○○ BLR00</li> <li>● TRS5-○○ BLR00V</li> </ul>  <p>(mm)</p>	0°C to 130°C	±2.5°C		Rice cookers Hot water heaters Thermos-type hot water heaters	General-purpose
High-Precision Type	<ul style="list-style-type: none"> <li>● TRS5-○○ BLR000</li> </ul>  <p>(mm)</p>	40°C to 100°C	±1°C			High-precision

\*1 Please consult us before you determine specifications.

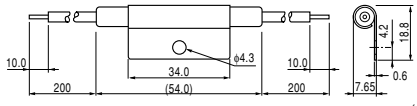
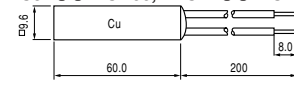
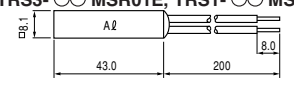
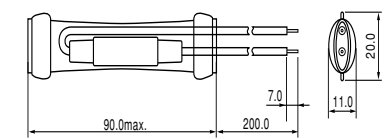
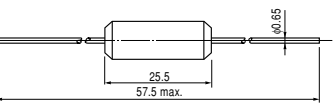
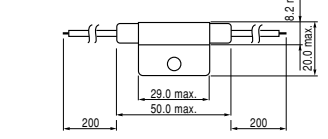

- All specifications in this catalog and production status of products are subject to change without notice. Prior to the purchase, please contact NEC TOKIN for updated product data.
- Please request for a specification sheet for detailed product data prior to the purchase.
- Before using the product in this catalog, please read "Precautions" and other safety precautions listed in the printed version catalog.

<p><b>L Type (Make Type)</b></p>	<p>● TRS3- ○ MLR00, TRS1- ○ MLR00V</p>  <p>(mm)</p>	<p>0°C to 130°C</p>	<p>±2.5°C</p>		<p>Power supplies Computers &amp; peripherals</p>	<p>General-purpose</p>
<p><b>S Type</b></p>	<p>● TRS5- ○ BSR00, 00V ● TRS3- ○ MSR00, TRS1- ○ MSR00V</p>  <p>● TRS5- ○ BSR01E, 01EV ● TRS3- ○ MSR01E, TRS1- ○ MSR01EV</p>  <p>(mm)</p>	<p>-10°C to 100°C</p>	<p>±2.5°C</p>		<p>Air-conditioners Freezers Vending machines Refrigerators Anti-freeze heaters</p>	<p>Humidity-and moisture-resistant</p>
<p><b>T Type</b></p>	<p>● TRS5- ○ BTR01, 01V ● TRS3- ○ MTR01, TRS1- ○ MTR01V</p>  <p>(mm)</p>	<p>-10°C to 60°C</p>	<p>±2.5°C</p>	<p>10°C max.</p>		
<p><b>Mold TRS Type</b></p>	<p>● M-TRS5- ○ B</p>  <p>(mm)</p>	<p>-10°C to 130°C</p>	<p>±2.5°C</p>		<p>Anti-freeze heaters Aquarium heaters</p>	<p>Molded plastic</p>
<p><b>Approved by UL, CSA</b></p>	<p>● TRS5- ○ BLRU</p>  <p>(mm)</p>	<p>0°C to 130°C</p>	<p>±2.5°C</p>		<p>Photocopiers Rice cookers</p>	<p>Satisfies overseas safety standards- UL, CSA</p>





- All specifications in this catalog and production status of products are subject to change without notice. Prior to the purchase, please contact NEC TOKIN for updated product data.
- Please request for a specification sheet for detailed product data prior to the purchase.
- Before using the product in this catalog, please read "Precautions" and other safety precautions listed in the printed version catalog.

# TRS<sup>®</sup> Series Approved by UL,CSA,and VDE



## Specifications

Recognized by:	Model	Max.Make/Break Current	Max.Make/Break Voltage	Max.Make/Break Power	Shape No.	Set Operating Temperature Range (°C)	Operating Temperature precision (°C)	Differential Temperature (°C)*1
	BCR Series TRS5-○○○BCR01U	0.5A	140V AC	50W AC	A	0~120	±2.5	10 max.
	TRS5-○○○BCR01VU	0.275A	264V AC	60.5W AC				
	BLR Series TRS5-○○○BLR U	0.5A	140V AC	50W AC	B	0~130	±2.5	10 max.
	TRS5-○○○BLR VU	0.275A	264V AC	60.5W AC				
	BLR Series TRS5-○○○BLR U	0.5A	120V AC	50W AC	B	0~129	±2.5	10 max.
	TRS5-○○○BLR XU	0.25A	240V AC	60W AC				

UL : File No.E67648  
 CSA : File No.LR50414-2

\*1.No values specified in the international safety standard.  
 \*○○○indicates the operating temperature

## Shape and Dimensions

● A

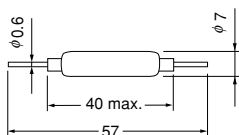

● B

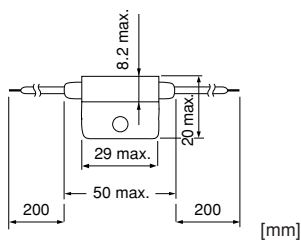

[mm]



- All specifications in this catalog and production status of products are subject to change without notice. Prior to the purchase, please contact NEC TOKIN for updated product data.
- Please request for a specification sheet for detailed product data prior to the purchase.
- Before using the product in this catalog, please read "Precautions" and other safety precautions listed in the printed version catalog.

# Thermal Guard OHD®



## Outline

The thermal guard “OHD®” is developed for thermal problem countermeasures and safety standard conformity that are becoming increasingly important for electronic devices in recent years.

## Features

- Extremely simple circuit design (as no adjustment needed).
- Reliable ON-OFF operation (special temperature-sensitive materials and highly-reliable switches give reproducible, reliable ON-OFF action).
- Usable with extremely low (0.1 mW or lower) signals to high power (6 W) levels, making them ideal as built-in overheating detectors in electronic circuits. (OHD5R-00B have a maximum rating of 1 W.)
- High-speed response (three times higher than previous NEC TOKIN products).
- Compact, light and easy to handle.
- Dust-proof, explosion-proof, and corrosion-proof.
- Wide range of operating temperatures available (in 5 °C increments from 30 to 130 °C)





## Applications

- Monitoring overheating of power transistors and power modules in power supplies, OA equipment and other electronic appliances.
- Atmospheric temperature detection and overheating monitoring in room heaters, gas hot water heaters, PPCs, amplifiers, motors, HDDs, FDDs and other general appliances.



- All specifications in this catalog and production status of products are subject to change without notice. Prior to the purchase, please contact NEC TOKIN for updated product data.
- Please request for a specification sheet for detailed product data prior to the purchase.
- Before using the product in this catalog, please read "Precautions" and other safety precautions listed in the printed version catalog.

Specifications

Product name	Features	Contact shape	Electrical Characteristics	Set operating temperature range*2	Operating temperature precision	Differential temperature
OHD1-  	General-purpose	B:Break M:Make	Maximum opening/closing voltage 110 V AC/DC Maximum opening/closing current 0.3 A AC/DC Maximum opening/closing power 6 W AC/DC Minimum opening/closing current 0.1mA/1V,DC	Fixed in 5°C increments from 30°C to 130°C	±5°C	10°C max.
OHD3- 						
OHD5R-  	Compact radial type	B:Break	Maximum opening/closing voltage 30 V.DC Maximum opening/closing current 0.1 A DC Maximum opening/closing power 1 W DC Minimum opening/closing current 0.1mA/1V,DC			

UL : E67648  
 CSA : LR50414  
 TÜV : OHD1-3 R 9750955  
 OHD5R R 9750944

\*1,2 Please consult us before you determine specifications.

Product name	Contact Resistance	Insulation Withstand Voltage	Insulation Resistance	Remarks
OHD1-3	150mΩ max.	2500VAC/1min. or 3000VAC/1sec (Between terminals and mounting resin surface)	DC500V-100MΩ min. (Between terminals and mounting resin surface)	Compliance to RoHS directive
OHD5R	300mΩ max.	1500VAC/1min. or 1800VAC/1sec (Between terminals and mounting resin surface)	DC500V-100MΩ min. (Between terminals and mounting resin surface)	Compliance to RoHS directive

Standard Temperature Specifications

Product name	Standard temperature specification
OHD1-B	60. 80. 90. 100°C
OHD1-M	70°C
OHD3-B	60. 70. 80. 85. 90. 100. 105. 110. 120°C
OHD3-M	80. 85. 90. 95. 100. 105. 110. 115. 120°C
OHD5R-B	80. 85. 90. 95. 100. 105. 110°C

\* Please ask separately except standard temperature specification

Markings

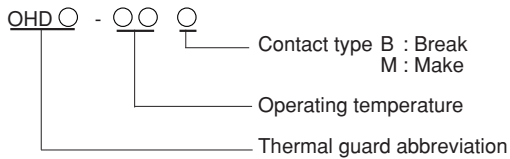

- All specifications in this catalog and production status of products are subject to change without notice. Prior to the purchase, please contact NEC TOKIN for updated product data.
- Please request for a specification sheet for detailed product data prior to the purchase.
- Before using the product in this catalog, please read "Precautions" and other safety precautions listed in the printed version catalog.

Shape and Dimensions

● OHD1

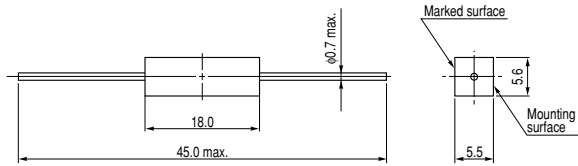

● OHD1 mounting bracket

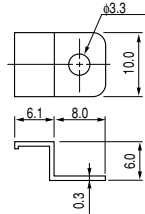

\*Mounting brackets exclusively for the OHD1 type are provided optionally (at separate cost).

● OHD3

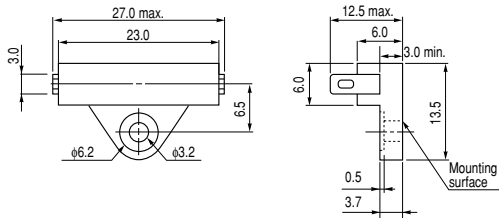

● OHD5R

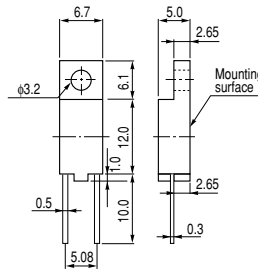

(mm)

**Before Using Thermal Guard OHD®**

- Please ask for a copy of specification and check the contents thoroughly before the actual use.
- Do not use OHD® under mechanical weight load.
- Do NOT use with greater load than specified.
- Do not affix in close proximity to strongly magnetized parts and avoid using in a magnetic field.
- Do not use if dropped or strongly shocked.
- The OHD1 is designed to be inserted into printed circuit boards. OHD3 type is reed wire soldered type.



- All specifications in this catalog and production status of products are subject to change without notice. Prior to the purchase, please contact NEC TOKIN for updated product data.
- Please request for a specification sheet for detailed product data prior to the purchase.
- Before using the product in this catalog, please read "Precautions" and other safety precautions listed in the printed version catalog.

# Current Transformers Low Current Type

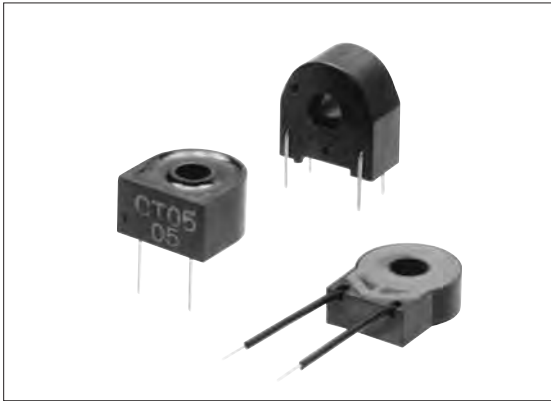

## Outline

This series of compact current transformers (current sensors) can be used for detecting very low current levels and overcurrent protection in electronic appliances.

## Features

- High sensitivity (detection of low current) and high performance.
- Compact, lightweight.
- Mountable on printed circuit boards.

## Applications

- Overcurrent detection in microcomputer-controlled equipment.
- Current detection in electric refrigerators, air conditioners and electromagnetic cookers.

## Specifications

Product name	CT-05	CT-06	CT-07
Core	Permalloy	Permalloy	Permalloy
Lead wires	φ0.6 mm Pin connectors	Polyethylene sheath φ0.5 mm single wire	φ0.8 mm Pin connectors
Materials	Phenolic resin case, epoxy-filled	Phenolic resin case, silicon-filled	Phenolic resin case, epoxy-filled
Remarks	Compliance to RoHS directive	Compliance to RoHS directive	Compliance to RoHS directive

- Notes: (1) The CT-05 has 500<sup>r</sup> as standard.  
 (2) In the standard lineup there are three types of CT-06, depending on differences in secondary windings.  
 (3) In the standard lineup there are two types of CT-07, depending on differences in secondary windings.

## Shape and Dimensions

### ● CT-05

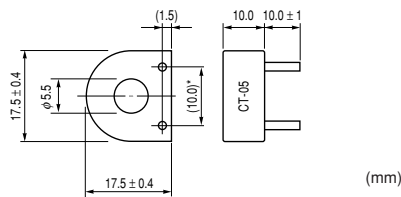

### ● CT-06

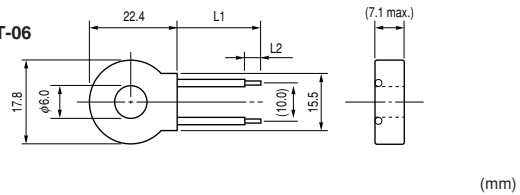

### ● CT-07

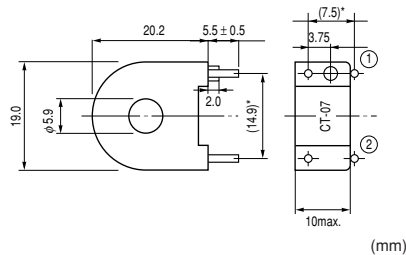

Product name	L1(±5)	L2(±2)
CT-06-50	56.0	4.0
CT-06-75	85.0	5.0

- \* Tolerance ±0.3
- \* Pin root diameter.



- All specifications in this catalog and production status of products are subject to change without notice. Prior to the purchase, please contact NEC TOKIN for updated product data.
- Please request for a specification sheet for detailed product data prior to the purchase.
- Before using the product in this catalog, please read "Precautions" and other safety precautions listed in the printed version catalog.

**Output Characteristics**

- CT-05, CT-07 AC output characteristics (example)
- CT-06 AC output characteristics (example)

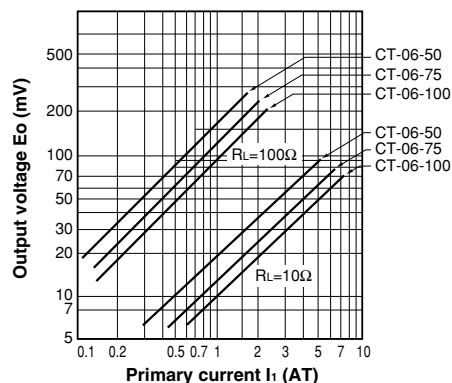
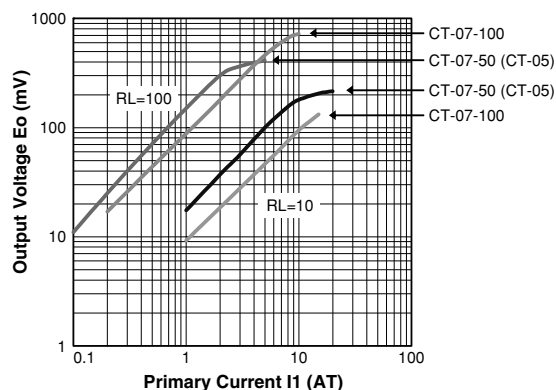

• **Measuring circuit**

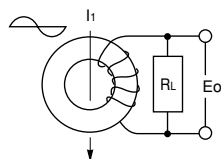

$I_1$  : Primary current (AT)  
 $R_L$  : Load resistance ( $\Omega$ )  
 $E_o$  : Output voltage (mV rms)

**Before Using Current Transformers Low Current Type**

- The core may be damaged if applied with a strong impact. Carefully avoid dropping or applying any other strong impacts.
- Preliminary study is needed with regard to heating by current conduction.
- Do not use the current transformer opened between secondary output terminals.  
 In the worst case, heat build-up in the magnetic core may occur, resulting in damages to the parts by the melting of coil due to this heat.



- All specifications in this catalog and production status of products are subject to change without notice. Prior to the purchase, please contact NEC TOKIN for updated product data.
- Please request for a specification sheet for detailed product data prior to the purchase.
- Before using the product in this catalog, please read "Precautions" and other safety precautions listed in the printed version catalog.

# Zero-Phase Current Transformers ZCT

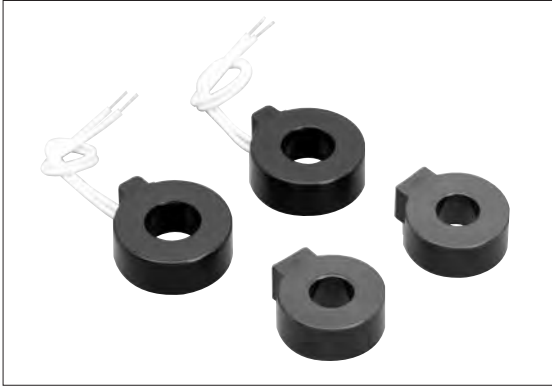

### Outline

The ZCT Series of compact molded-type zero-phase current transformers is ideal for improving the sensitivity, compactness and light weight of electric shock prevention earth leakage breakers.

### Features

- High sensitivity.
- Compact and light weight.
- Laminated iron core type.

### Applications

- Electric shock prevention earth leakage breakers.
- Short circuit relays.

### Shape and Dimensions

● MR-1,2,3,4

● MR-1-P5

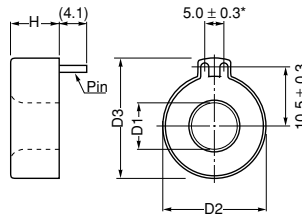
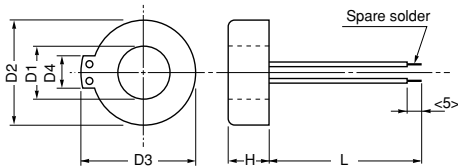

Product name	Each part's dimensions (mm)					
	D1 (min)	D2 (max)	D3 (max)	D4	H (max)	L (±3.0)
MR-1	7.3	19.5	22.3	(5.0)	8.3	40.0
MR-2	8.5	22.0	25.0	(5.0)	8.3	80.0
MR-3	11.0	28.0	30.5	(6.0)	10.5	67.0
MR-4	16.5	32.0	34.5	(7.0)	10.8	67.0
MR-1-P5	7.4	19.3	21.8	(8.0)	8.5	—

Pin :  $\phi 0.8$  mm Pin connectors.

\* Pin root diameter.

### Specifications

Product name	Output voltage (mV) min.	Temperature characteristics (-20°C to 80°C) (%) max.	Overinput characteristics (After DC5A input) (%) max.	Measurement conditions	(Ref.) Rated current for leakage breaker (A)	Remarks
MR-1	8	-10 to +10	10	f=60Hz R=300 $\Omega$ I <sub>o</sub> =22.5 mA	30	Compliance to RoHS directive
MR-2					30	
MR-3					60	
MR-4					125	
MR-1-P5					30	

Notes1: We can accommodate other specifications as well, so please ask if required.

R : Load resistance, I<sub>o</sub> = I<sub>o</sub> : Detection current

Notes2: As rated current may vary depending on mounting condition, it is necessary to check its value after the actual mounting on to the component.



- All specifications in this catalog and production status of products are subject to change without notice. Prior to the purchase, please contact NEC TOKIN for updated product data.
- Please request for a specification sheet for detailed product data prior to the purchase.
- Before using the product in this catalog, please read "Precautions" and other safety precautions listed in the printed version catalog.

**Before Using Zero-Phase Current Transformers ZCT**

- Strong shocks such as from being dropped may change the characteristics. Take care to avoid any subjecting the transformers to physical shocks.
- Do not use the current transformer opened between secondary output terminals.  
In the worst case, heat build-up in the magnetic core may occur, resulting in damages to the parts by the melting of coil due to this heat.
- ZCT can be used as current transformer. In this case, please request us for data.



- All specifications in this catalog and production status of products are subject to change without notice. Prior to the purchase, please contact NEC TOKIN for updated product data.
- Please request for a specification sheet for detailed product data prior to the purchase.
- Before using the product in this catalog, please read "Precautions" and other safety precautions listed in the printed version catalog.

# Magnetic Direct Current Sensor MDCS®

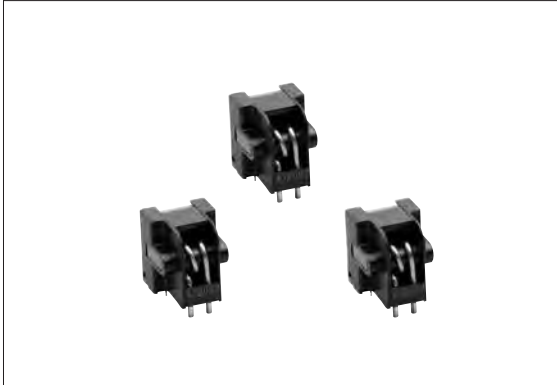

## Outline

Magnetic direct current sensors (MDCS®) use a magnetic substance and hole device for magnetic detection of direct current. They detect all currents (DC, AC and pulse), and the output voltage varies in proportion to the strength of the current measured.

## Features

- Detection of both direct currents and alternating currents (including pulse currents)
- Fluctuations in output from changes in the power supply voltage and the ambient temperature are small.
- Excellent linearity of measured current and the converted power output
- The measured current and the secondary output side are insulated.

## Applications

- Inverter-based home appliances (Air-conditioners etc.)
- General-purpose inverters
- AC variable-speed drive and servo drive
- Industrial machines • UPS • DC motor control
- FAX and other multifunction telephone series (THS Series)

Item	Marking	Rated value and conditions (Ta=25°C)													
		Amplifier built-in type													
		Single power supply operating type (Magnetic proportion system)													
Model	IcL1	LA12													
		10V21	12V21-2	15V21	20V21	24V21-2	25V21	30V21	32V21	36V21-2	40V21	48V21	50V21	60V21	
Rated current (A)	IcL1	±10	±12	±15	±20	±24	±25	±30	±32	±36	±40	±48	±50	±60	
Primary side windings *1 (Turn)		6	6	4	3	3	2	2	2	2	2	2	2	1	
Scope of measurement		0 to 100% of rated current (IcL1)													
Power supply voltage (V)	Vcc	+12 ± 5%													
	Vee	-													
Consumption current (mA) max.		40													
Output voltage (V)	Vh	± 2.000 ± 0.060 (at IcL1, RL=10KΩ)													
Residual voltage (V)	Voff	± 2.500 ± 0.060 (at 0A, RL=10KΩ)													
Hysteresis (mV) max.	Vhys	60													
Power supply voltage variation (mV) max.		30 (Vcc=+12V ± 5%)													
Vh temperature characteristics (%/°C)		±0.15													
Voff temperature characteristics (mV/°C)		±4													
Pulse response (μs) max.	Tp	20 (di/dt=100AT/μs)													
Linearity (%)	g	-2 to 2													
Insulation withstand voltage		AC2000V/1min. (Between wire and terminals)													
Insulation resistance		500MΩ/DC500V (Between wire and terminals)													
Operating temperature range (°C)	Ta	-10 to +75													
Storage temperature range (°C)	Ts	-15 to +80													

\*1 Besides the standard windings, any other windings within the rated current are possible.

\*2 Sample delivery for this model may take extra time.



- All specifications in this catalog and production status of products are subject to change without notice. Prior to the purchase, please contact NEC TOKIN for updated product data.
- Please request for a specification sheet for detailed product data prior to the purchase.
- Before using the product in this catalog, please read "Precautions" and other safety precautions listed in the printed version catalog.

● THS56,56F,65,63F

Electrical Characteristics (Ta=25°C, Vcc=+5V)

Item		Marking	Conditions	Rating			Comments	
				min.	typ.	max.		
Sensitivity current	(mA)	56,65	lL	Ta=+5°C~+45°C	2		15	
			lH					
	56F,63F	lL	5			10		
		lH						
Primary side input current	(mA)	56,56F,63F,65	lin		-120		120	
Input direct current resistance	(Ω)	56	Rin	Ta=-10°C~+70°C	2.5	3.5	4.5	
		56F,63F,65			2.5	3.9	5.0	
Input inductance	(mH)	56	Lin	Ta=-10°C~+70°C	0.8	1.0	1.2	
		56F,63F,65			0.8	1.1	1.4	
Output voltage		(V)	V <sub>OH</sub> V <sub>OL</sub>	RL=10kΩ	3.5	0.1	0.8	
Response		(μS)	ton-off	RL=∞		60		
Power supply voltage		(V)	Vcc		+4.5		+5.5	
Consumption current	(mA)	56,56F,65	Icc			10		
		63F				12		
Effect of external magnetic field		(mA)	lin offset	lin=0 B=1×10 <sup>-3</sup> T		3		
"Analog" out put	Loss	(dB)		lin=0~120mA 1kHz,600Ω	56,65	30	34	38
					56F	30	33	36
					63F	-2	0	2
	S/N	(dB)			56,56F,65	15		

Model change scheduled in 2010  
\*For all models of THS series

Maximum Rating

Item	Marking	Rating	Comments
Power supply voltage (V)	V <sub>CC</sub>	7.0	
Primary side input current (A)	56,56F,63F,65	lin	10sec. max.
Withstand voltage between primary and secondary (kVAC) min.		2.2	60sec. 50Hz RH=65±5%
Operating temperature range (°C)	Topt.	-10 ~ +70	
Storage temperature range (°C)	Tstg.	-20 ~ +80	

Input Current - Output Voltage Characteristics

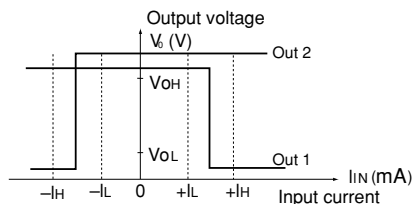

- All specifications in this catalog and production status of products are subject to change without notice. Prior to the purchase, please contact NEC TOKIN for updated product data.
- Please request for a specification sheet for detailed product data prior to the purchase.
- Before using the product in this catalog, please read "Precautions" and other safety precautions listed in the printed version catalog.

Shape and Dimensions

● LA12-10V21 to LA12-24V21

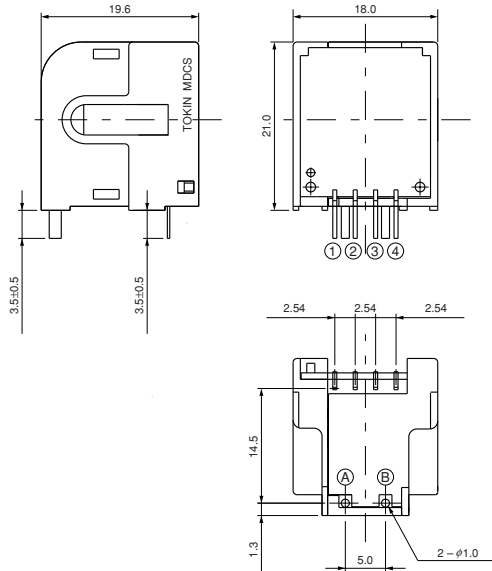

● LA12-25V21 to LA12-60V21

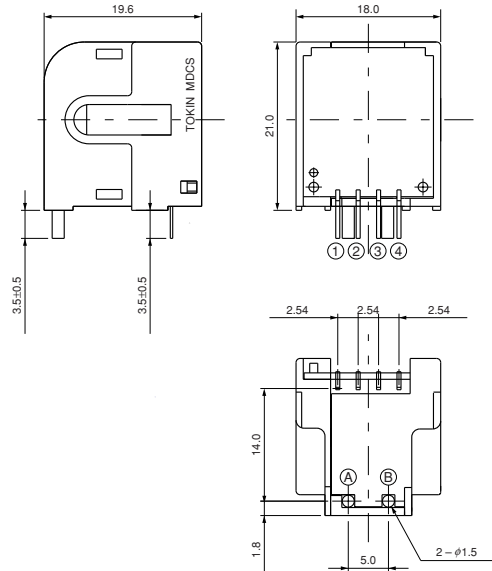

● THS-56,56F,65

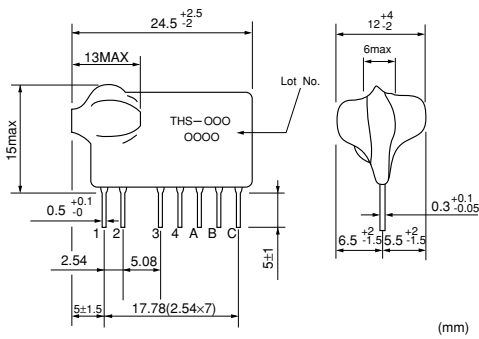

● THS-63F

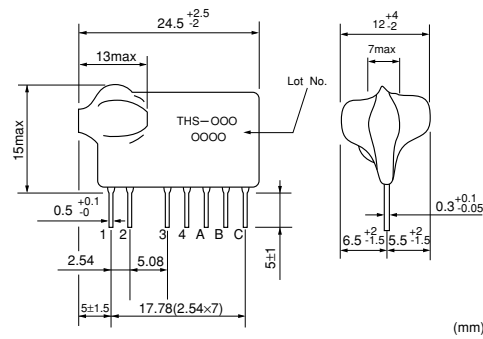

Pin number	LA12	THS56,56F,65,63F
1	NC GND	(Coil input)
2	(Ground pin)	(Coil input)
3	Vcc (+12V)	GND (Ground pin)
4	Vout (Output voltage pin)	"Analog" output
A	(Measured current ⊕ pin)	OUT2
B	(Measured current ⊖ pin)	OUT1
C	—	Vcc (+5V)

**Model change scheduled in 2010**  
 \*For all models of THS series



- All specifications in this catalog and production status of products are subject to change without notice. Prior to the purchase, please contact NEC TOKIN for updated product data.
- Please request for a specification sheet for detailed product data prior to the purchase.
- Before using the product in this catalog, please read "Precautions" and other safety precautions listed in the printed version catalog.

**Before Using Magnetic Direct Current Sensor MDCS®**

- Strong physical shocks could damage cores. Be careful not to drop or apply other strong impact.
- These products are heat resistant up to 260°C for 10 seconds. Be careful not to exceed this amount when soldering. Use a low-corrosion type flux when soldering.
- Because the circuit uses ICs, application of strong static electricity could cause damage. Take static electricity precautions when handling.
- Because these products are magnetic current detectors, application of strong external magnetic fields could cause their characteristics to change. Limit ambient magnetic fields to 50e or less.



- All specifications in this catalog and production status of products are subject to change without notice. Prior to the purchase, please contact NEC TOKIN for updated product data.
- Please request for a specification sheet for detailed product data prior to the purchase.
- Before using the product in this catalog, please read "Precautions" and other safety precautions listed in the printed version catalog.

# Magnetic Type Proximity Switches TMRS® Series



## Outline

NEC TOKIN's highly reliable magnetic non-contact switches are the result of combining reed switches and magnets, made possible by the contact technology, magnetic circuit technology and plastic molding technology developed through the production of 300 million temperature switches (TMRS® Series).

## Applications

- Position detection (air cylinders, automatic doors, etc.)
- Rotation detection

## Features

- Sealed resin-molded structure makes for easy handling and mechanical strength.
- The contacts are encased in glass for excellent resistance to dust and corrosion.

## Operation Characteristics

- Normally open type

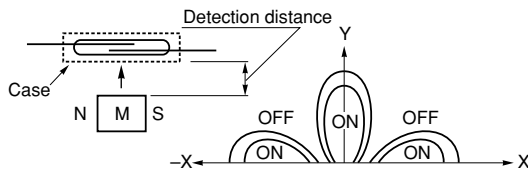

When drive magnet M approaches, the reed switch contacts close and the circuit comes on.

## Specifications

	Product name	Features	Electrical characteristics	Life time
TMRS Series	TMRS-3020	Compact wire harness	Maximum switching voltage 110V AC/DC Maximum switching current 0.5A AC/DC	12VDC 5mA (R)
	TMRS-4001	General wire harness	Maximum switching power 10W AC/DC	10 <sup>7</sup> times



- All specifications in this catalog and production status of products are subject to change without notice. Prior to the purchase, please contact NEC TOKIN for updated product data.
- Please request for a specification sheet for detailed product data prior to the purchase.
- Before using the product in this catalog, please read "Precautions" and other safety precautions listed in the printed version catalog.

**Markings**

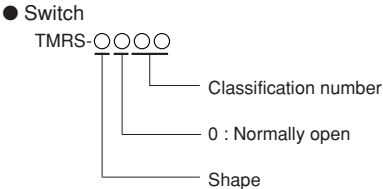

**Shape and Dimensions**

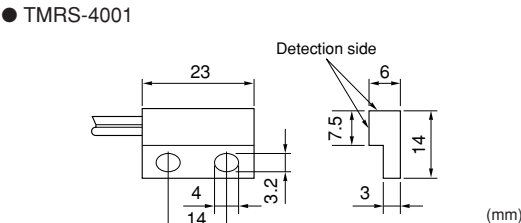
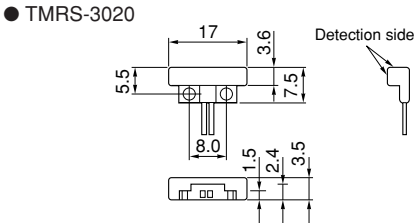

● All specifications in this catalog and production status of products are subject to change without notice. Prior to the purchase, please contact NEC TOKIN for updated product data.  
 ● Please request for a specification sheet for detailed product data prior to the purchase.  
 ● Before using the product in this catalog, please read "Precautions" and other safety precautions listed in the printed version catalog.

**Before Using Proximity Switch Series**

**Fixing the Proximity Switch**

When fixing a proximity switch, avoid warping as shown in Figure 1 caused by rise of filler or an obstacle left on the mounting surface. Also, do not pull a reed wire.

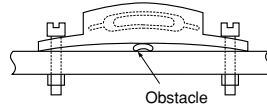

Figure 1 Warping caused by an obstacle left between the proximity switch and the mounting surface.

**Cautions for Shock**

- (1) As the characteristics of the proximity switch (especially sensitive) may deteriorate when the switch falls from above 30cm height, caution must be taken.
- (2) If many proximity switches are mounted on a large print board, caution must be taken when cutting the print board along the perforated line, because the shock of cutting may change the sensitivity of the switch. (Along with an effort such as leaving the least part to reduce the shock, we recommend that you confirm that the sensitivity has not changed before use.)

**Contact Protection Circuit**

For improving the reliability of the proximity switch, insert one of the following contact protection circuits when using the switch at a load which causes a surge current.

• Inductive load

If an inductance (coil, electromagnetic relay, motor, etc.) is used as a load, hundred of volts of counter electromotive force (the energy stored in the inductance) will occur to shorten the lifetime of the contact (for the resistance load, that is also true when an inductance is used at a high voltage or a large current). For protection circuits, refer to Figure 2.

Protection circuit with CR

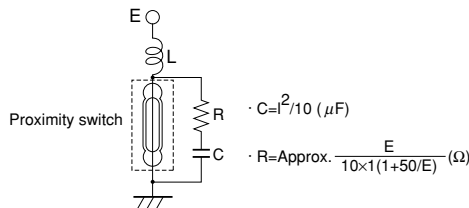

Protection circuit with varistor

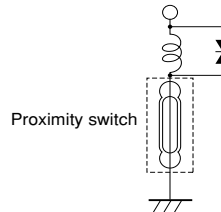

Protection circuit with diode

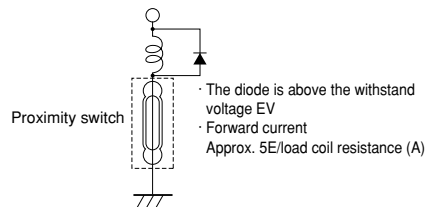

Figure 2



- All specifications in this catalog and production status of products are subject to change without notice. Prior to the purchase, please contact NEC TOKIN for updated product data.
- Please request for a specification sheet for detailed product data prior to the purchase.
- Before using the product in this catalog, please read "Precautions" and other safety precautions listed in the printed version catalog.

- Capacity load  
If a condenser is used as a load, charge/discharge at the capacitance will cause a rush current when the switch is closed, which may make switch opening impossible. In this case, as shown in Figure 3, the method in which a protection resistance R is inserted can be used.

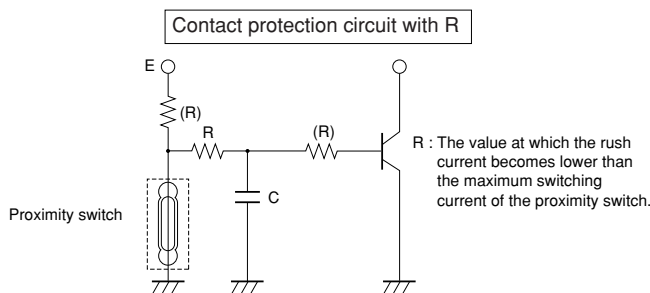

Figure 3

- Lamp load  
In general, the filament of the lamp is made of tungsten. With the tungsten filament, the resistance is low when the lamp is turned on and becomes higher as it reaches the stationary current. When this lamp is used with a proximity switch, a rush current (at five to ten times the stationary current) will be caused immediately after lighting, which may result in welding or adhering of the contact. In this case, as shown in Figure 4, a protection resistor R can be inserted.

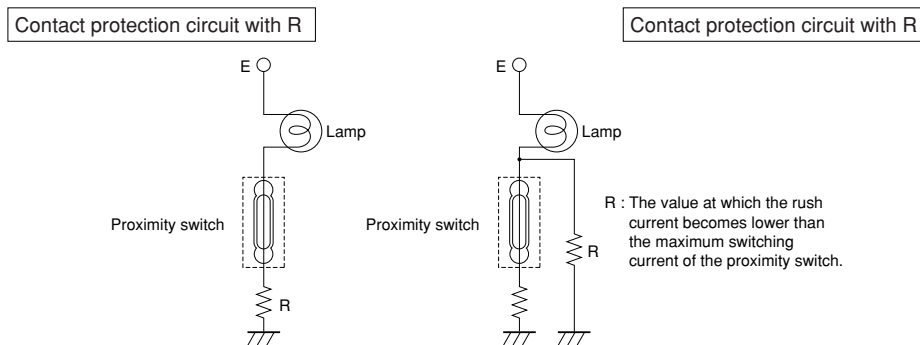

Figure 4

- Wiring capacity load  
If a contact and a load are combined by long wires or cable, the floating capacity will cause a rush current when the contact is closed, which largely affects the lifetime of the contact. In this case, as shown in Figure 5, a protection circuit in which a resistance or inductance is added can be used.

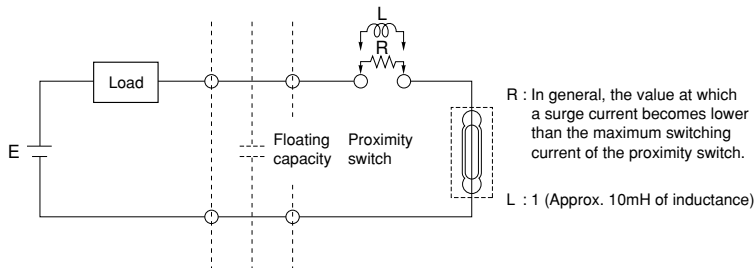

Figure 5



● All specifications in this catalog and production status of products are subject to change without notice. Prior to the purchase, please contact NEC TOKIN for updated product data.  
● Please request for a specification sheet for detailed product data prior to the purchase.  
● Before using the product in this catalog, please read "Precautions" and other safety precautions listed in the printed version catalog.

**Cautions for Ultrasonic**

- Ultrasonic cleaning  
After mounting a proximity switch on a printed circuit board or the like, avoid ultrasonic cleaning because ultrasonic cleaning may change the sensitivity of the switch or crack the seal of the glass tube.
- Ultrasonic welding  
Also, avoid ultrasonic welding because, by the same reason as ultrasonic cleaning, the performance of the proximity switch may deteriorate.



- All specifications in this catalog and production status of products are subject to change without notice. Prior to the purchase, please contact NEC TOKIN for updated product data.
- Please request for a specification sheet for detailed product data prior to the purchase.
- Before using the product in this catalog, please read "Precautions" and other safety precautions listed in the printed version catalog.

● For inquiry, please call Sales Promotion Department(JAPAN)

Products	Section	Phone / Fax	Adress
Thermal Reed Switch (TRS <sup>®</sup> )	For inquiry, Please call Sales Promotion Department(JAPAN)	Phone:81-3-3515-9220 Fax:81-3-3515-9221	Chiyoda First Bldg., 8-1 Nishi-Kanda 3-chome, Chiyoda-ku, Tokyo 101-8362,Japan
TRS Series Approved by UL, CSA, and VDE			
Thermal Guard (OHD <sup>®</sup> )			
Current Transformer (low current type)			
Zero-Phase Current Transformer ZCT			
Magnetic Direct Current Sensor MDCS <sup>®</sup>			
Twin Reed Switch Type Safing Sensor High Stand Type:TMSD <sup>®</sup> -H**51D			
Ceramic Gyro			
Magnetic type Proximity Switches TMRS <sup>®</sup> Series			
Proximity Switches NRS Series			
Surface Mounting Type Reed Switches Case Type:NRS-700 Series			



- All specifications in this catalog and production status of products are subject to change without notice. Prior to the purchase, please contact NEC TOKIN for updated product data.
- Please request for a specification sheet for detailed product data prior to the purchase.
- Before using the product in this catalog, please read "Precautions" and other safety precautions listed in the printed version catalog.



- All specifications in this catalog and production status of products are subject to change without notice. Prior to the purchase, please contact NEC TOKIN for updated product data.
- Please request for a specification sheet for detailed product data prior to the purchase.
- Before using the product in this catalog, please read "Precautions" and other safety precautions listed in the printed version catalog.

# Precautions



- The names of the products and the specifications in this catalog are subject to change without notice for the sake of improvement. The manufacturer also reserves the right to discontinue any of these products. At the time of delivery, please ask for specifications sheets to check the contents in order to use the products properly and safely.
  - Descriptions in this catalog regarding product characteristics and quality are based solely on discrete components. When using these components, be sure to check the specifications with the component in question mounted on the products.
  - Each sensor in this catalog may malfunction or break down in a particular mode. When designing products, be sure to include a countermeasure for this eventuality.
  - The manufacturer's warranty will not cover any disadvantage or damage caused by improper use of the products that deviates from the characteristics, specifications, or conditions for use described in this catalog.
  - The products in this catalog are intended for use in ordinary electronic products. If any of these products are to be used in special applications requiring extremely high reliability, such as in aviation equipment and nuclear power controllers where product defects might pose a safety risk, please consult your NEC TOKIN sales representatives.
  - Though the manufacturer has taken all possible precautions to ensure the quality and reliability of its products, improper use of products may result in bodily injury, fire, or similar accident. If you have any questions regarding the use of the products in question, please consult your NEC TOKIN sales representatives.
  - Please be advised that the manufacturer accepts no responsibility for any infraction by users of the manufacturer's products on third party patents or industrial copyrights. The manufacturer is responsible only when such infractions are attributable to the structural design of the product and its manufacturing process.
- Export Control
    - For customers outside Japan  
NEC-TOKIN products should not be used or sold for use in the development, production, stockpiling or utilization of any conventional weapons or mass-destructive weapons (nuclear weapons, chemical or biological weapons, or missiles), or any other weapons.
    - For customers in Japan  
For products which are controlled items subject to the 'Foreign Exchange and Foreign Trade Law' of Japan, the export license specified by the law is required for export.
  - This catalog is current as of March 2010.



- All specifications in this catalog and production status of products are subject to change without notice. Prior to the purchase, please contact NEC TOKIN for updated product data.
- Please request for a specification sheet for detailed product data prior to the purchase.
- Before using the product in this catalog, please read "Precautions" and other safety precautions listed in the printed version catalog.